



**Cabinet Doors & Drawer Boxes**

# PRODUCT GUIDE

**CRAFTSMANSHIP. SERVICE. QUALITY.**  
SINCE 1995



## COMPANY HISTORY

Since opening in 1995, Corona Millworks has grown into a leading supplier of Cabinet Doors, Drawer Boxes, and Components to the cabinet industry.

CMW continually strives to provide excellent quality, a broad selection, and superior service. This is done in the true spirit of partnership and desire to build long term relationships in the cabinet industry. All products are manufactured from the finest materials and each order is custom produced to your specifications. We fabricate all essential pieces for your residential and commercial applications at our Southern California facilities.

From mill to delivery, Corona Millworks is the #1 source for craftsmanship, service, and quality to satisfy all your cabinet door and component needs.

# PROUDLY MADE IN THE USA SINCE 1995

## CONTENTS

Cope-N-Stick Wood Doors	4
Mitered Wood Doors	6
Moulding & Contemporary Wood Doors	8
Wood Door Outside Edge Options	9
Wood Door Profiles	10
PUR Edgeband E-Series Doors	12
Thermofoil Doors	14
Thermofoil Door Outside Edge Options	16
Thermofoil Door Profiles	16
Drawer Boxes	17
Specialty Drawer Boxes, Inserts, & Options	18
Hardware	20
Components: Base Cabinets	22
Components: Apron Cabinets	24
Components: Upper Cabinets	25
Components: Tall Cabinets	26
Components: Hutches	27
Components: Fillers	27

## CONTACT INFORMATION

**Will Call Center**  
13855 Redwood Avenue  
Chino, California 91710

**Corporate Office**  
5572 Edison Avenue  
Chino, California 91710



**Order** 800.200.0975  
**Office** 909.606.3288  
**Fax** 909.606.3270



**CoronaMillworks.com**  
info@coronamillworks.com



*Specifications and details featured in this guide are subject to change.  
Please contact customer service for questions or more detailed product information.*

# COPE-N-STICK WOOD DOORS

ASTRON



ASHLEY



DURHAM



ORION



HELIO



MALLAGA



BROOKS



ALEXIS



HARLEY



SYLVAN



ARIEL



BAHIA



PRISCILLA



SCOTTSDALE



BARBOUR



CAPTIVA



SNOWDEN



ACUARIO



# MITERED WOOD DOORS

DAYTONA



RIO



LAGUNA



NEWPORT



PANAMA



CORTINA



DERBY



DIPLOMAT



AMBER



PIPELINE



CAMBRIA



SAMANTHA



HUNTINGTON



BOYD



MANCHESTER



WESTON



BELMONT



CASTLEWOOD



# MOULDING & CONTEMPORARY WOOD DOORS

CARLTON



HORIZON



SHERIDON



ALINA



STRAGER



WRIGHT



PINNACLE



DONOVAN *(True Louver)*

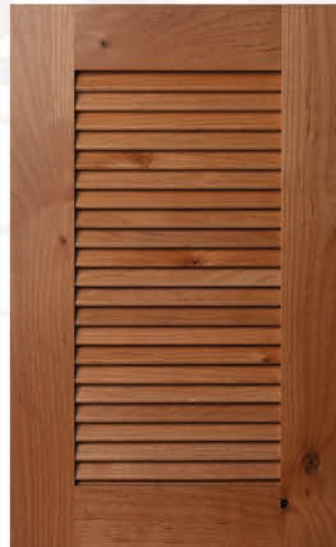

RAYA





# WOOD DOOR OUTSIDE EDGE OPTIONS



## SPECIALTY DOORS

**Our craftsmen can fabricate a wide range of specialty doors.**

We offer Arched, Eyebrow, French Lites, Wainscot, Valances, Special Panels, and much more.

For more information please contact your account representative or customer service at 800.200.0975. Additional information can also be found on our website at [CoronaMillworks.com](http://CoronaMillworks.com)

# WOOD DOOR PROFILES

ACUARIO

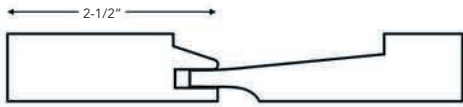

ALEXIS

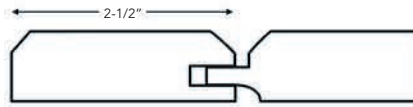

ALINA

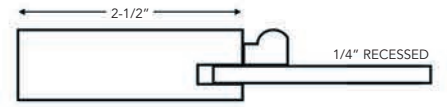

ASTRON

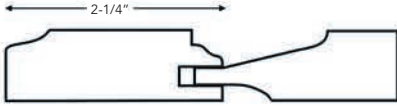

BAHIA

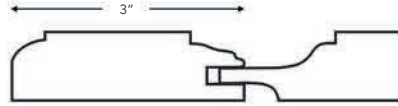

BARBOUR

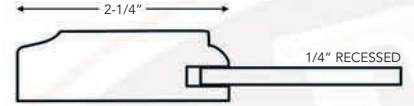

CAMBRIA

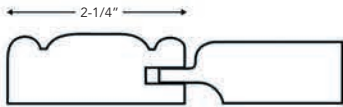

CAPTIVA

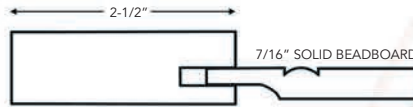

CARLTON

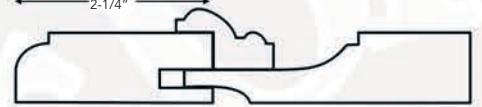

DERBY

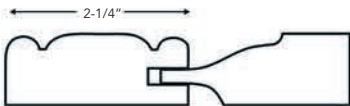

DIPLOMAT

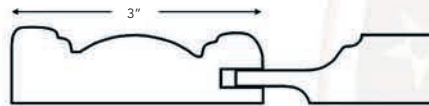

DONOVAN

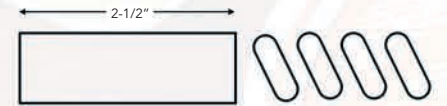

HORIZON

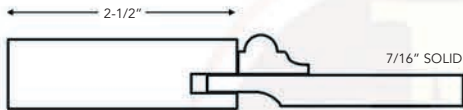

HUNTINGTON



LAGUNA



ORION

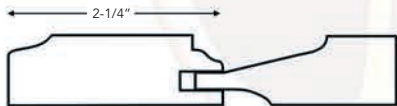

PANAMA

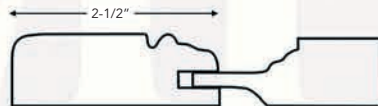

PINNACLE

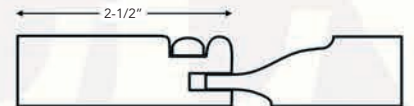

RIO

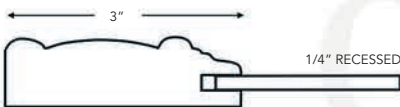

SCOTTSDALE

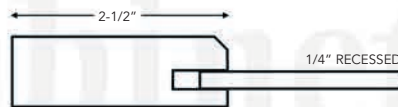

SHERIDON

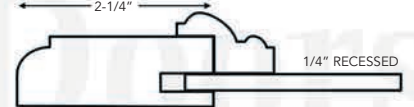

SYLVAN

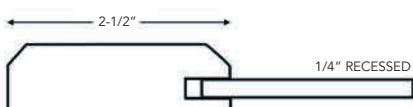

WESTON

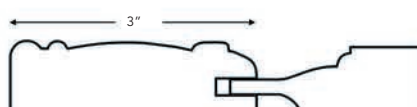

WRIGHT

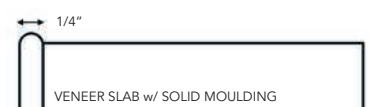

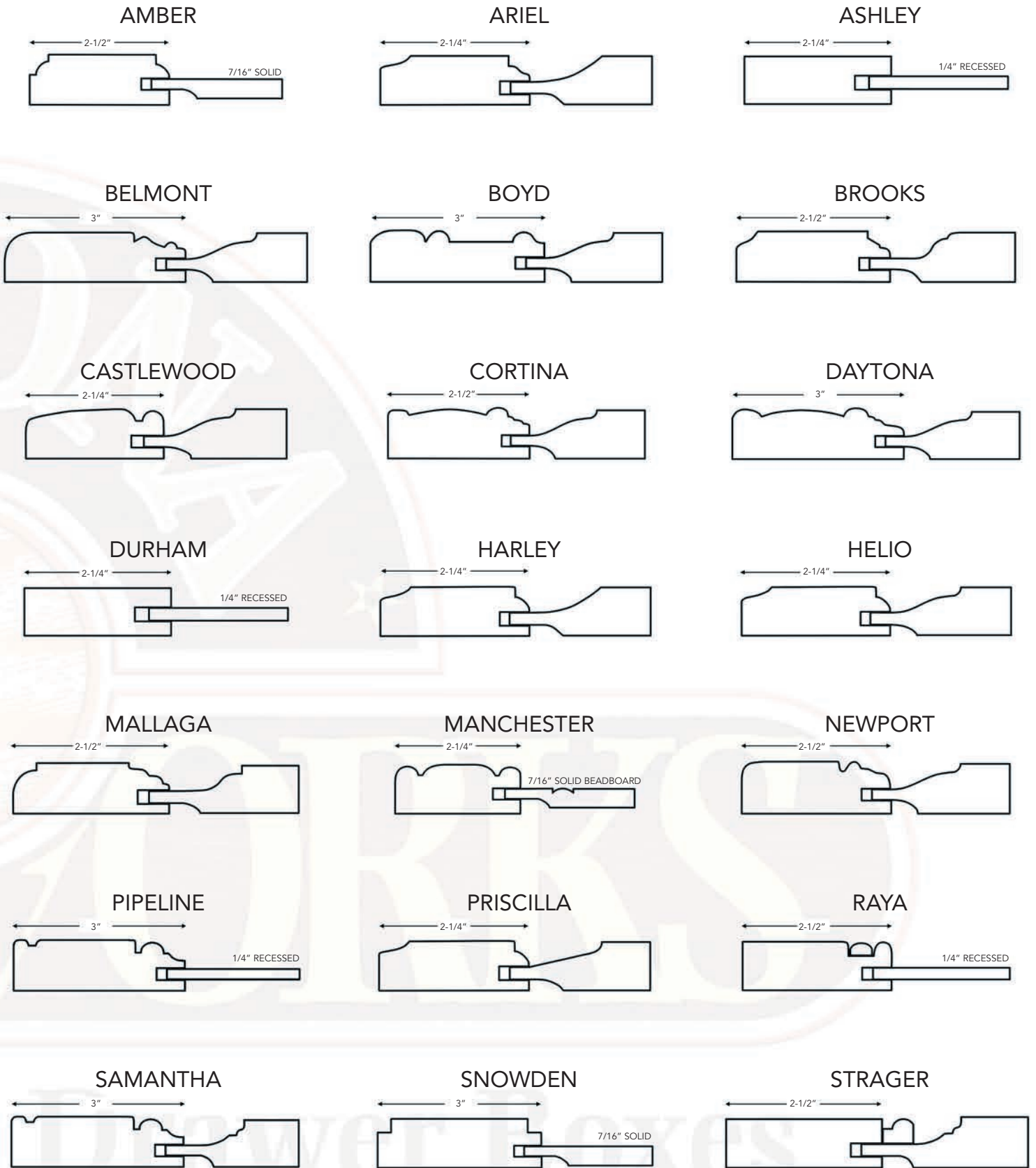

*Profiles are shown with the door's standard frame width and outside edge detail.*

*Matching 5-Piece, Solid Slab, and Routed Drawer Fronts are available for most door styles.*

*Optional frame widths and outside edge options are available for most doors.*

# MODERN SLAB

5-PIECE (*Recessed Panel*)



3-PIECE



1-PIECE



SPECIFY VERTICAL OR HORIZONTAL GRAIN WHEN ORDERING  
GRAIN MATCHING IS AVAILABLE

**PUR** GLUELINE

E-Series doors and drawer fronts manufactured by Corona Millworks feature a nearly invisible glue line.

Our IMA Novimat Contour edge bander uses less glue and provides better penetration without losing the strength of the bond. PUR (Polyurethane) adhesive can be up to six times more moisture resistant than EVA glues, and possesses a faster curing time.

PUR adhesives are unfilled, produces tight joints and is transparent so it can be used with edge banding of almost any color. Additionally, these doors are more resistant to heat, water, moisture, and steam.

# PUR EDGEBAND MATERIAL OPTIONS

arauco  
**PRISM**

**Luxe**<sup>®</sup>  
by ALNICO  
PATENTED PRODUCT

**StyleLite**<sup>®</sup>

**SALT**  
INTERNATIONAL

## TEXTURED & STANDARD **MELAMINE**

Available Edge Banding: .5mm | 1mm | 3mm  
FEATURING PRISM ARAUCO TFL MATERIALS  
ADDITIONAL LOCALLY STOCKED OPTIONS AVAILABLE

## HIGH GLOSS & MATTE **ACRYLIC**

Available Edge Banding: 1mm  
FEATURING STYLELITE MATERIALS  
ADDITIONAL LOCALLY STOCKED OPTIONS AVAILABLE

## HIGH PRESSURE **LAMINATE**

Available PVC Edge Banding: .5mm | 1mm | 3mm  
CUSTOM MATERIAL LAY-UPS AVAILABLE  
YOU CHOOSE THE FACE, BACK, CORE, & COLOR

## WOOD **VENEER**

Available Edge Banding: .5mm | 1mm | 3mm  
CHOOSE FROM A WIDE SELECTION OF WOOD SPECIES  
MDF & PLYWOOD CORE SUBSTRATES AVAILABLE



## **MIX & MATCH**

YOUR DOOR MATERIAL & EDGE BANDING  
FOR A CUSTOM DESIGNER LOOK

# THERMOFOIL DOORS

CM 131



CM 756



CM 100



CM 400



CM 540



CM 712



CM 766



CM 977



CM 732



CM 785



CM 810



CM 942



# THERMOFOIL DOOR OUTSIDE EDGE OPTIONS



# THERMOFOIL DOOR PROFILES



CM 100



CM 131



CM 400



CM 540

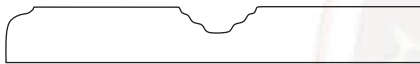

CM 712



CM 732

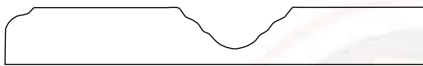

CM 756



CM 766



CM 785



CM 810

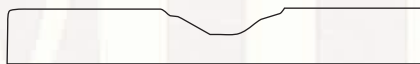

CM 942



CM 977

## AN EXCELLENT ALTERNATIVE TO PAINT & STAIN

Corona Millworks Thermofoil Series Doors do not chip or flake and are uniform in color. These doors are available in a wide range of colors, finishes, and textures. From solid colors, to wood grains, to high-gloss options we offer finishes to fit most any design style.

Rigid thermofoil doors and drawer fronts are composed of an MDF core with a thermo wrapped vinyl covering. If cared for properly these doors will provide years of long lasting use and beauty. Because these doors do not have to be stained there are no harmful environmental emissions either.



# DOVETAIL & DOWEL DRAWER BOXES

## SIDE MATERIALS

### Prefinished & Unfinished Plywood

- 1/2" or 5/8" Baltic Birch
- 1/2" or 5/8" Europly Maple

### Unfinished Solid Wood

- 1/2" or 5/8" Maple (Soft)
- 1/2" or 5/8" Maple (Select White)
- 1/2" or 5/8" Alder
- 1/2" or 5/8" Aspen
- 1/2" or 5/8" Beech
- 1/2" or 5/8" Cherry
- 1/2" or 5/8" Oak (Red)

*\*All solid material is finished after assembly*

### Melamine

- 1/2" or 5/8" White Melamine
- 1/2" Maple Melamine
- 1/2" Black Melamine
- 1/2" Almond Melamine
- 1/2" White Melamine (w/MDF Core)

*\*Available in doweled construction only*

---

## TOP EDGES

- Bull Nose
- Square
- Square Flush

---

## TOP FINISHES

- Clear Foil
- PVC Tape
- Wood Tape

---

## BOTTOM MATERIALS

### Finished & Unfinished Plywood

- 1/4" or 1/2" Maple
- 1/4" or 1/2" Alder
- 1/4" or 1/2" Beech
- 1/4" or 1/2" Birch
- 1/4" or 1/2" Cherry
- 1/4" or 1/2" Red Oak

### Melamine

- 1/4" or 1/2" White Melamine
- 1/4" or 1/2" Maple Melamine
- 1/4" or 1/2" Black Melamine
- 1/4" or 1/2" Almond Melamine

---

## BOTTOM RECESS OPTIONS

- 1/4" or 1/2" Recess
- Flush Mount
- Bottom Mount



**5~7 DAY  
LEAD TIME**

For Most Drawer Box Orders

# SPECIALTY & INSERTS DRAWER BOXES



ANGLE BOX



SCALLOP BOX



FILE BOX  
*Letter & Legal Options*



CORNER BOX



SPICE INSERT



UTENSIL INSERT  
*7 Options Available*



TRASH PULL-OUT  
*Single Bin Option Available*



SPICE PULL-OUT  
*Adjustable Middle Shelf*



UNDER SINK PULL-OUT

## SCOOP OPTIONS



#1  
3" x 1"



#2  
2-1/4" x 1-1/8"



#3  
4-1/8" x 1"

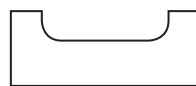

#4  
4" x 1"



#5  
3-3/4" x 1-3/4"



#6  
4-3/4" x 1-3/8"

# NOTCH & DRILL YOUR BOXES

To provide a quick and easy installation, Corona Millworks can construct drawer boxes that are notched & drilled at the factory for use with under-mount drawer slides.

Clips can also be pre-installed for your convenience.



## SLIDES & CLIPS

UNDER-MOUNT & SIDE-MOUNT  
OPTIONS AVAILABLE



## LASER LOGO ENGRAVING

Go ahead and sign your work.

Give the lasting impression of a custom crafted drawer box by leaving a signature of your craftsmanship with your company logo.

For the best results we recommend laser engraving on solid wood and plywood materials.

*\*There is a one-time laser logo setup charge.*



# HARDWARE KNOBS, PULLS, & MORE

## *CLASSIC* STYLES

AVAILABLE IN A WIDE RANGE OF FINISHES



## BAR PULLS

SATIN NICKEL FINISH



AVAILABLE IN THE FOLLOWING SIZES:

2" | 6" | 8" | 10" | 12" | 14" | 16" | 18" | 20" | 22" | 24" | 26" | 28" | 30"

CLEAR BUMPER



SHELF PIN



3/4" SPACER



## SCREWS & FASTENERS

VARIOUS TYPES & SIZES IN STOCK



# HARDWARE HINGES & PLATES

## FULL OVERLAY, HALF OVERLAY, & INSET

SOFT & SELF CLOSE PAIRINGS AVAILABLE

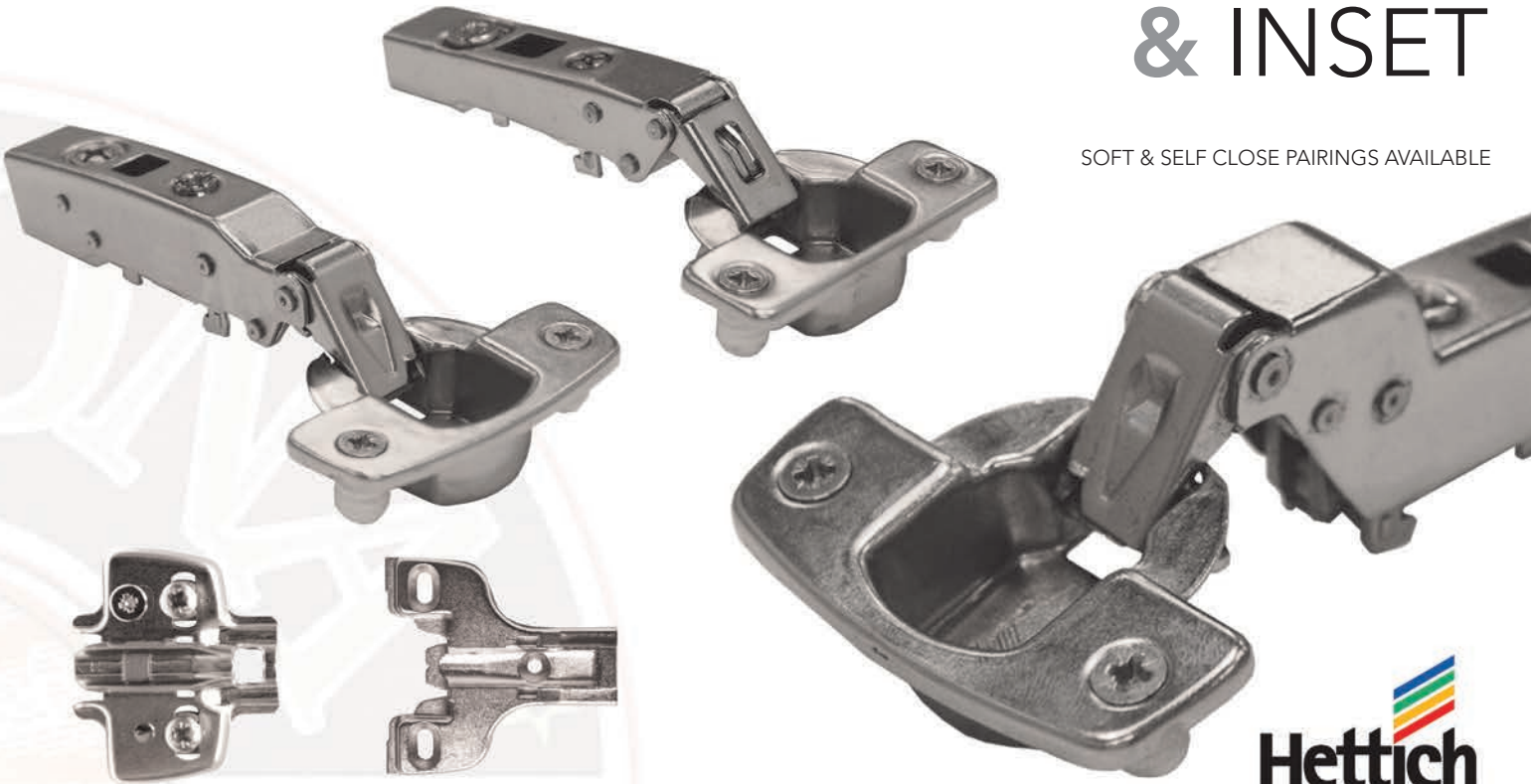

## POSTS & CORBELS

MULTIPLE WOOD SPECIES & STYLES OFFERED

VISIT [CORONAMILLWORKS.COM](http://CORONAMILLWORKS.COM) TO BROWSE OUR CURRENT SELECTION



POST B



POST C



CORBEL A1

# COMPONENTS BASE CABINETS

MADE TO ORDER

## COMPONENTS & CABINET PARTS

The Corona Millworks cabinet library provides a wide selection of CNC manufactured Base, Upper, Tall, & Specialty Cabinets. Parts can be fabricated in most sheet good materials and feature PUR edgebanding.

We manufacture our cabinets with no standard or stock sizes, thus every component order is produced to your specified width, depth, and height, then shipped to you ready to assemble.

## LET US CUT & EDGE BAND YOUR PARTS

Spend more time selling and installing jobs by having Corona Millworks fabricate all our components.

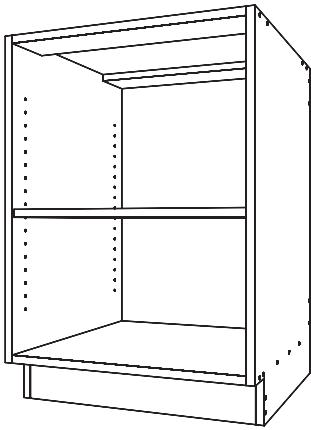

CM100  
Open Base Cabinet

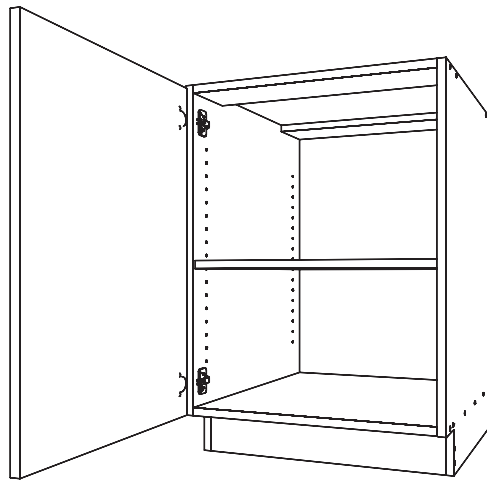

CM101  
One Door Base Cabinet

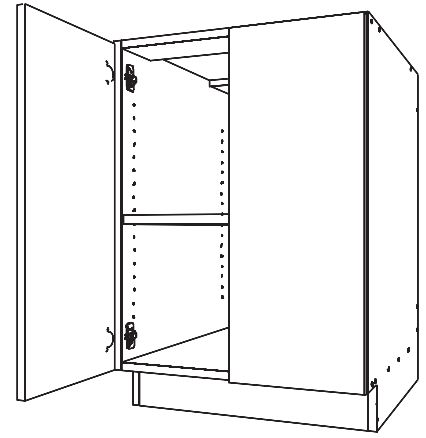

CM102  
Two Door Base Cabinet

## BASE APRON / SINK CABINETS

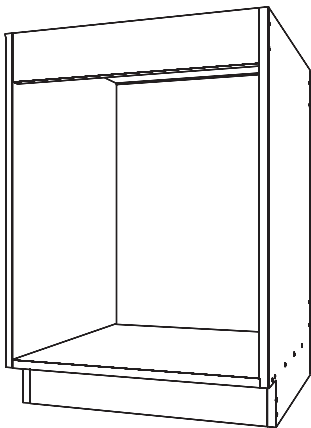

CM140  
Open Base Apron Cabinet

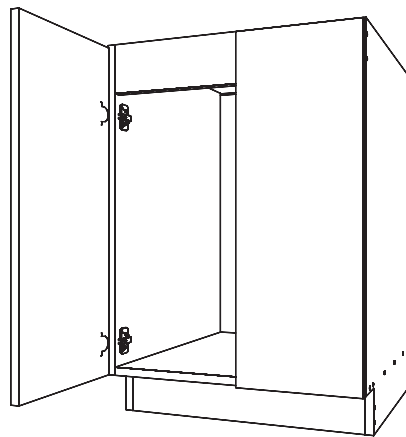

CM142  
Two Door Base Apron Cabinet

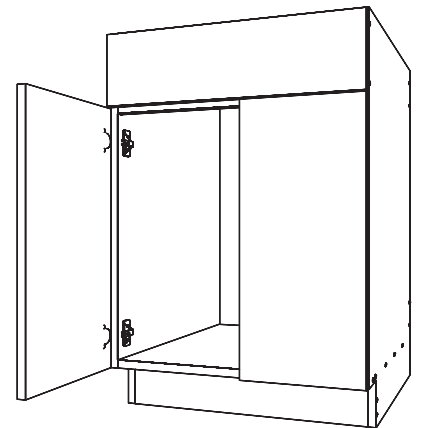

CM152  
Two Door - False Front Base Cabinet

# COMPONENTS BASE CABINETS

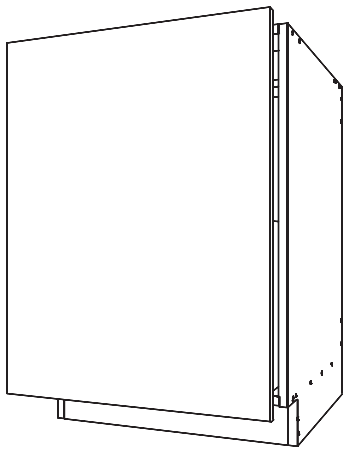

CM200  
One Drawer Base Cabinet

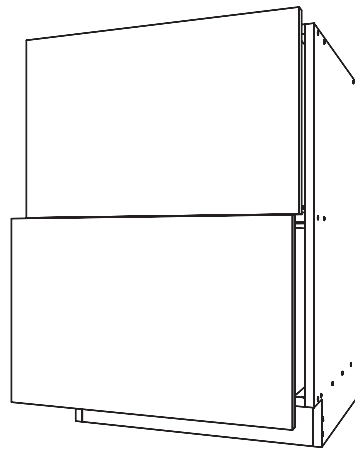

CM220  
Two Drawer Base Cabinet

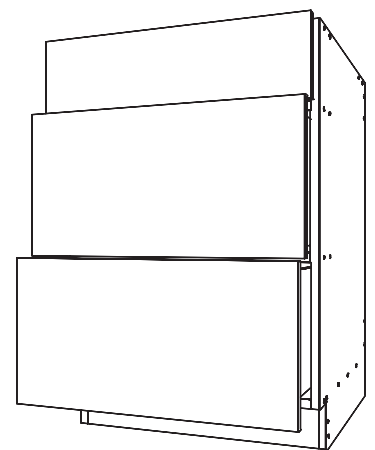

CM230  
Three Drawer Base Cabinet

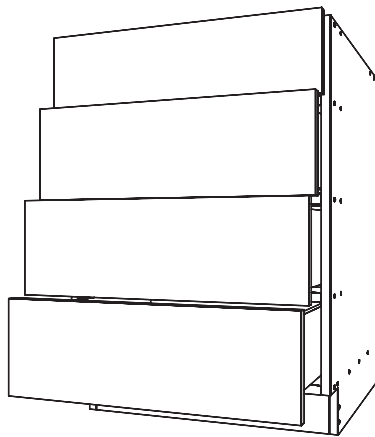

CM240  
Four Drawer Base Cabinet

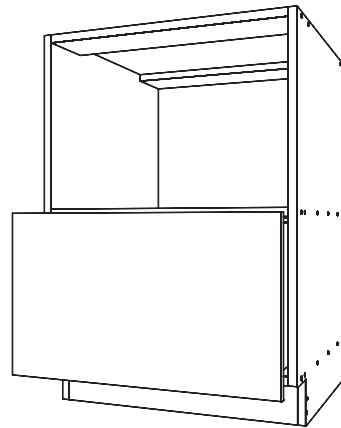

CM201  
One Drawer - Open Base Cabinet

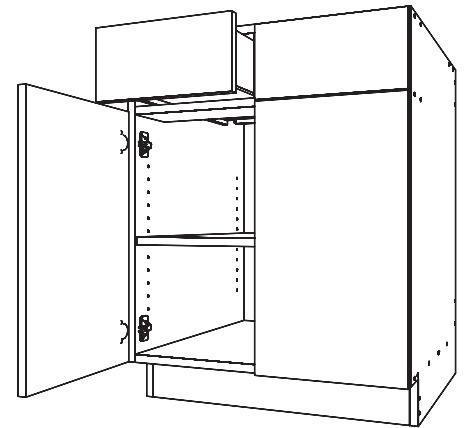

CM222  
Two Door - Two Drawer Base Cabinet

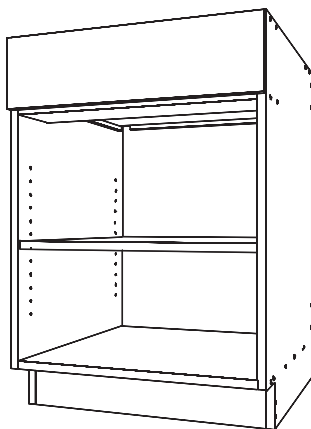

CM210  
Top Drawer - Open Base Cabinet

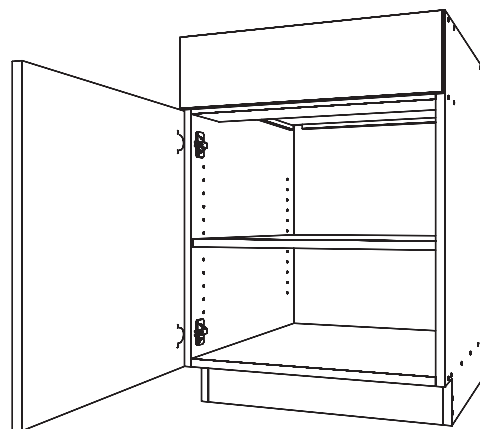

CM211  
Top Drawer - One Door Base Cabinet

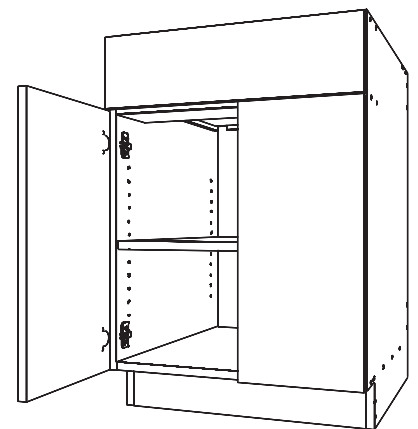

CM212  
Top Drawer - Two Door Base Cabinet

# COMPONENTS BASE CABINETS

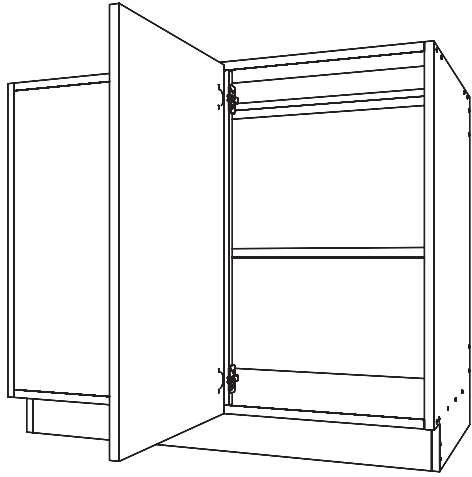

CM176

One Door - Single Blind Corner Base Cabinet

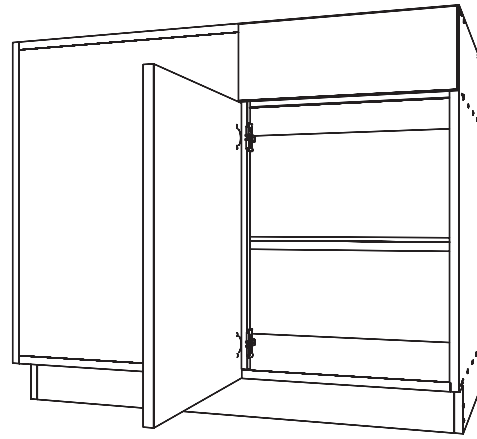

CM276

One Door - Top Drawer Single Blind Corner Base Cabinet

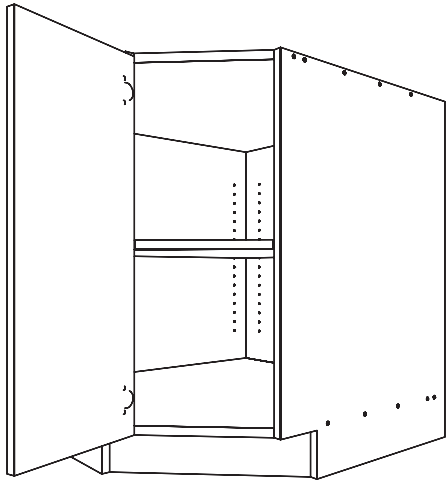

CM186

One Door - 45 Degree Corner Base Cabinet

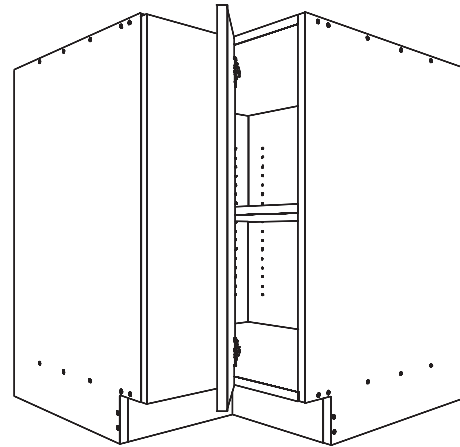

CM197

Two Door - 90 Degree Corner Base Cabinet

# APRON CABINETS

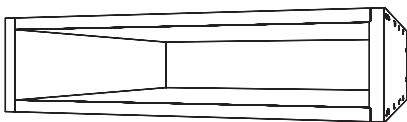

CM190

Open Storage Apron Cabinet



CM290

One Drawer Storage Apron Cabinet

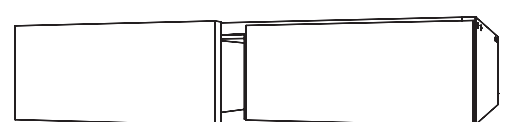

CM291

Two Drawer Storage Apron Cabinet



# COMPONENTS UPPER CABINETS

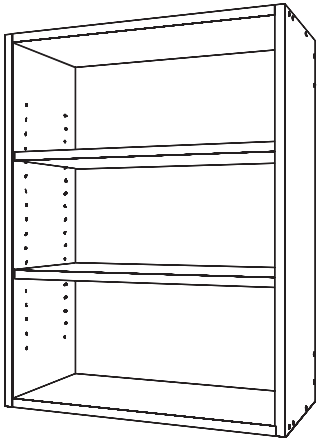

CM300  
Open Upper Cabinet

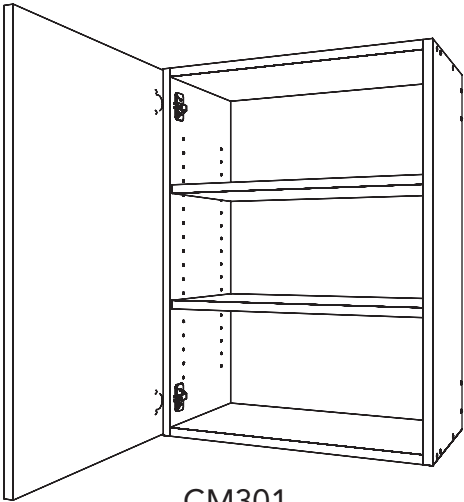

CM301  
One Door Upper Cabinet

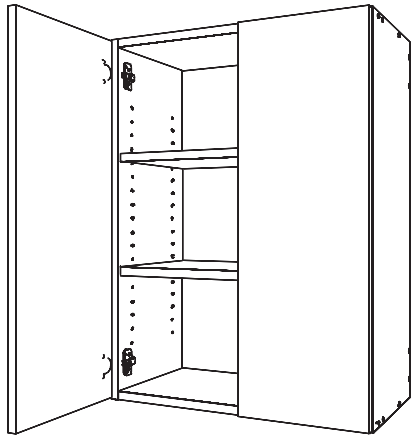

CM302  
Two Door Upper Cabinet

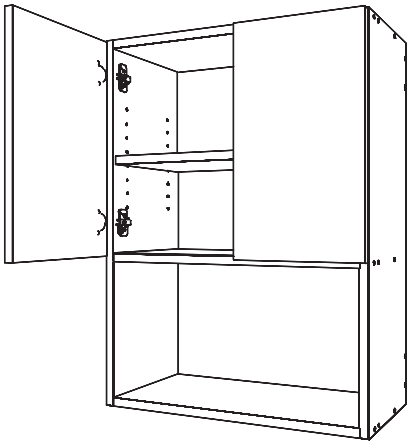

CM326  
Partial Open - Two Door Upper Cabinet

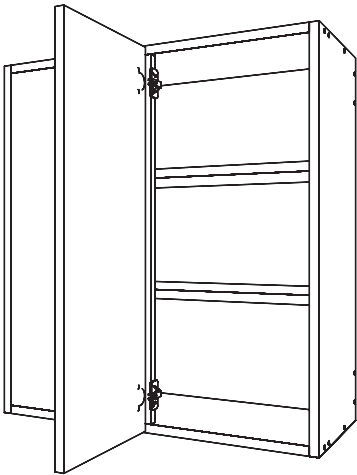

CM376  
One Door - Single Blind Corner Upper Cabinet

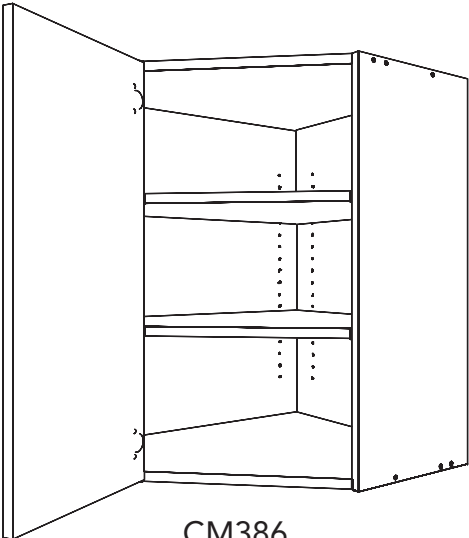

CM386  
One Door - 45 Degree Corner Upper Cabinet

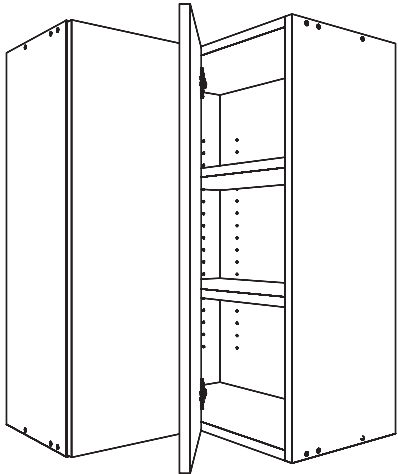

CM397  
Two Door - 90 Degree Corner Upper Cabinet

# COMPONENTS TALL CABINETS

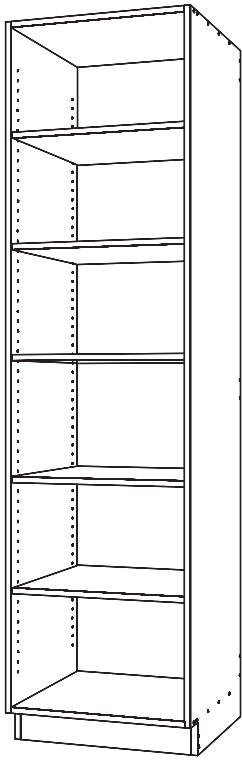

CM400  
Open Tall Cabinet

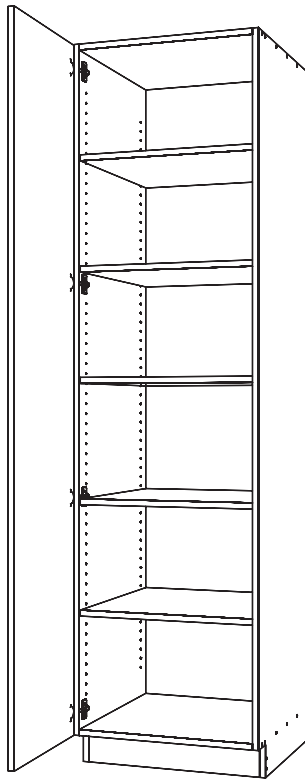

CM401  
One Door Tall Cabinet

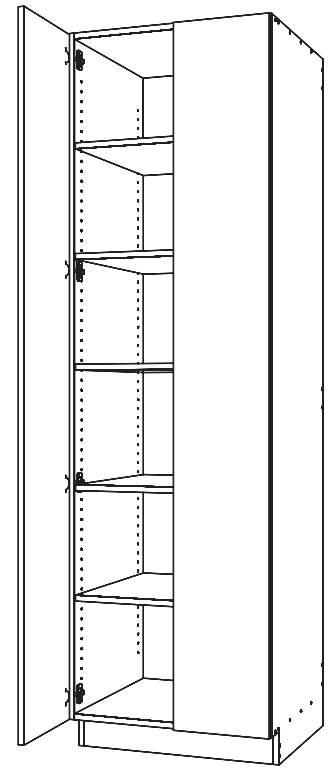

CM402  
Two Door Tall Cabinet

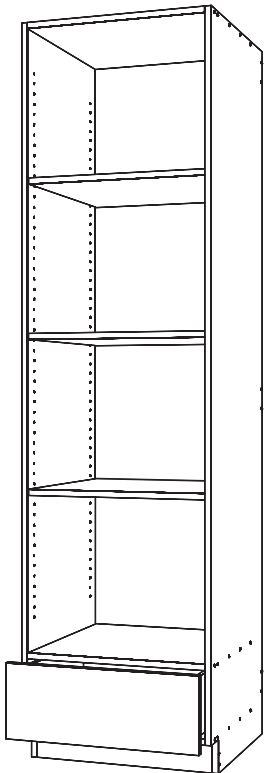

CM810  
Open - One Drawer Tall Cabinet

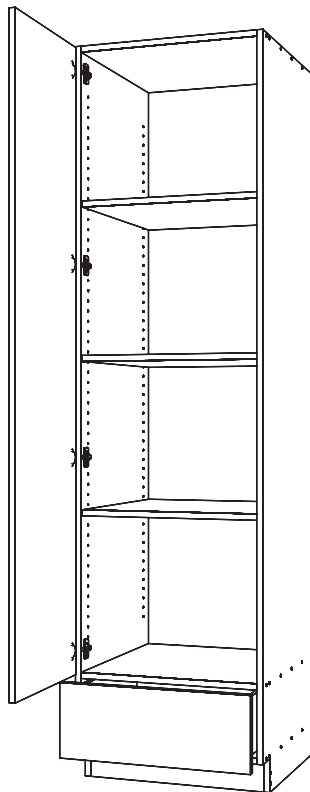

CM811  
One Door - One Drawer Tall Cabinet

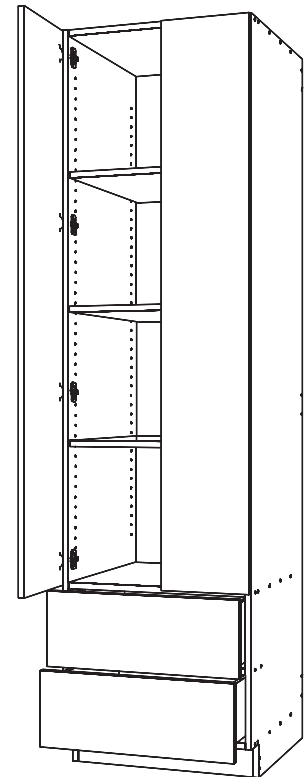

CM820  
Two Door - Two Drawer Tall Cabinet

# COMPONENTS TALL CABINETS

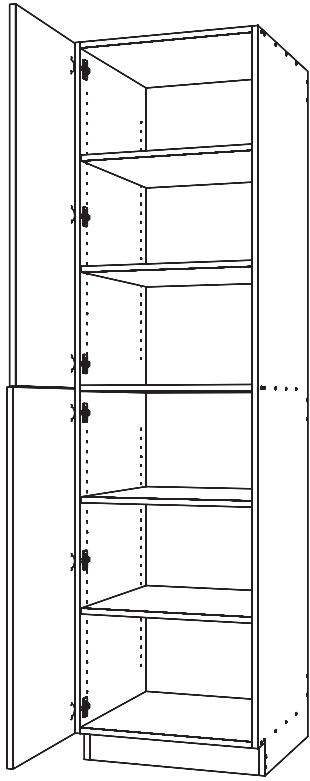

CM423  
Two Door Split Tall Cabinet

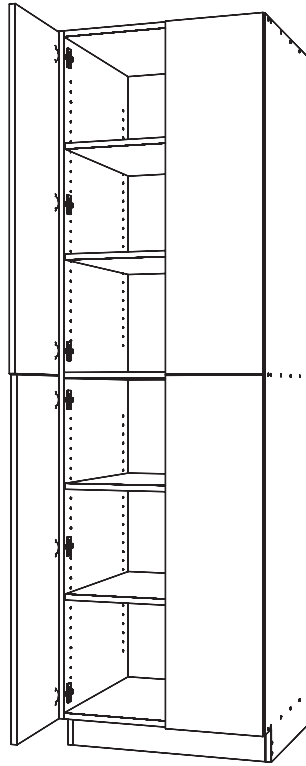

CM424  
Four Door Split Tall Cabinet

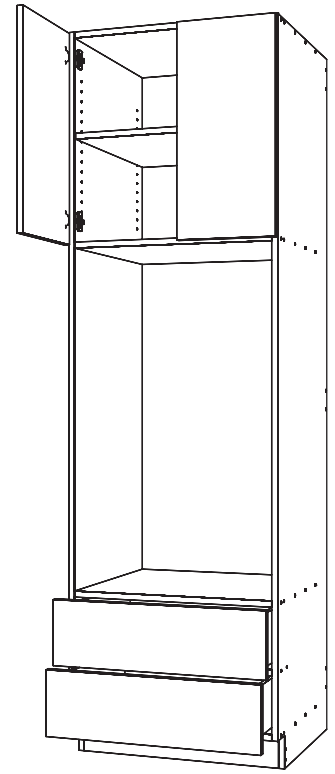

CM822-O  
Two Door - Two Drawer Oven Cabinet

# HUTCH CABINETS

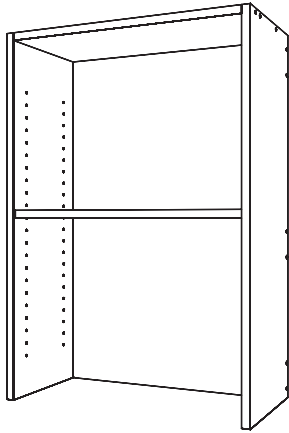

CM440  
Open Hutch Cabinet

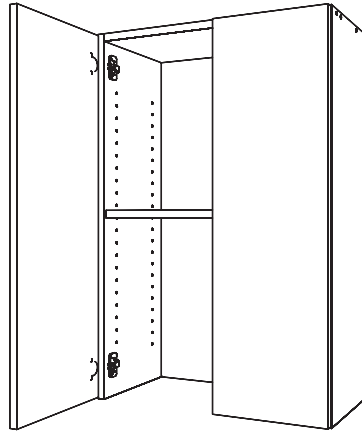

CM442  
Two Door Hutch Cabinet

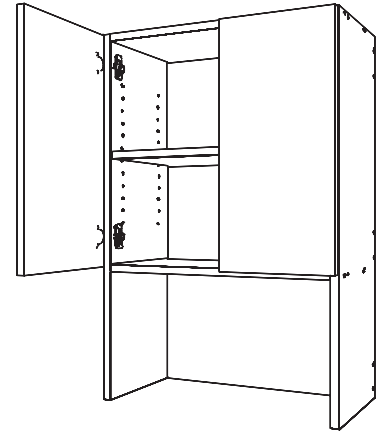

CM442-O  
Two Door - Open Hutch Cabinet

# FILLERS

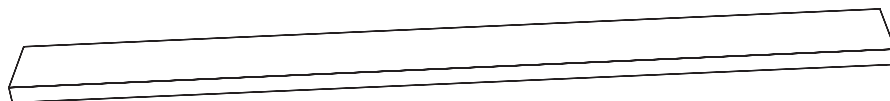

CM910  
Base Filler

CM930  
Upper Filler

CM940  
Tall Filler



Cabinet Doors & Drawer Boxes

WOOD DOORS | THERMOFOIL DOORS | DRAWER BOXES  
PUR EDGEBANDING | CABINETS COMPONENTS | HARDWARE

**SALES**  
800.200.0975

**OFFICE**  
909.606.3288

**FAX**  
909.606.3270

**ONLINE**  
[CoronaMillworks.com](http://CoronaMillworks.com)